

Neutral Earthing Resistors

For permanent or temporary neutral earthing in HV systems

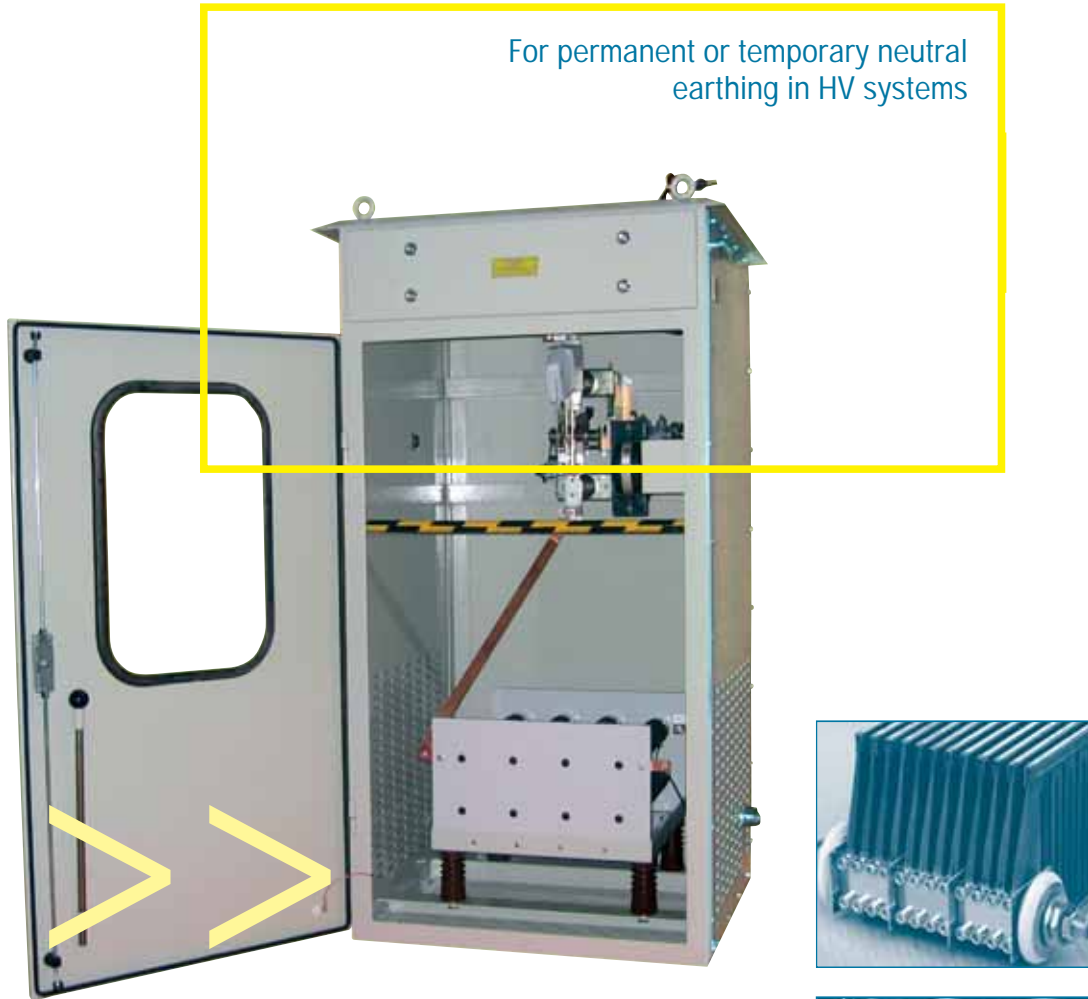

For continuous or temporary low-resistance neutral grounding in medium voltage systems

Neutral point connection

The method of neutral point connection in three-phase systems determines the power frequency voltage increase on non-defective phases in case of a ground fault.

The ratio of the root-mean-square value of the highest power frequency line-to-ground voltage (U_{LF}) of a phase, not affected by the ground fault to the root-mean-square value of the line-to-ground voltage U_L that would be available at the location under analysis under no-fault conditions, is named ground fault factor ε . This ground fault factor constitutes the decisive factor for the selection of the insulation level as per DIN 57111/VDE 0111.

Neutral point connection	$\varepsilon = U_{LF}/U_L$
Direct, $Z_0/Z_1 = 0$	1,0
Low-resistance $Z_0/Z_1 \sim 1...5$	1,1...1,4
High- resistance $Z_0/Z_1 \sim 20...100$	1,75...1,8
Compensated \rightarrow infinite	1,75...1,85
Isolated $Z_0/Z_1 \sim 100...200$	1,75...1,85
Z_0 = neutral point impedance [1]	
Z_1 = symmetrical supply impedance	

Direct neutral point grounding exhibits the following disadvantage: a single phase ground fault is also single phases short-circuit that allows short-circuit current flow that is only restricted by the impedance at the default location. There is no power frequency voltage increase in the healthy phases. In grids with an **insulated neutral point**, a ground fault bridges the earth capacitance of the affected phase. The ground fault current released corresponds to the sum of the capacitive currents of the other two phases with the voltage between each of the healthy phases and the ground rising to the line-to-line voltage.

Where the neutral point is grounded with a choke, the inductive impedance of which is equal to the capacitive impedance to ground, this is called a compensated system. Compensation of the line-to-earth capacity generates a voltage vector on the ground-fault-neutralizer that is directed against the voltage of the faulty phase and thus suppresses the fault arc. However, automatic suppression is only possible when compensation is almost complete and thus only suitable for systems with limited volumetric expansion. A continuous ground fault is hard to find due to the complex voltage conditions.

Low-resistance neutral point grounding is selected for extended systems. The neutral point is grounded with a resistor which restricts the ground fault current to a defined value up to the time when the system is switched off. The intensity of the default current depends on the resistance value and on the impedance at the ground fault location. The maximum ground fault current only occurs in case of a ground fault near a transformer. In this case, the voltage of the neutral point will rise to about that of the line-to-ground voltage. All other power frequency line voltages are not affected.

In order to detect a continuously occurring ground fault in compensated systems, a **brief low-resistance neutral point grounding** is used where a transformer neutral point is briefly grounded via a resistor actuated by a switchgear. Unlike continuous low-resistance neutral point grounding, only one resistor is required in this case for several transformers or generators.

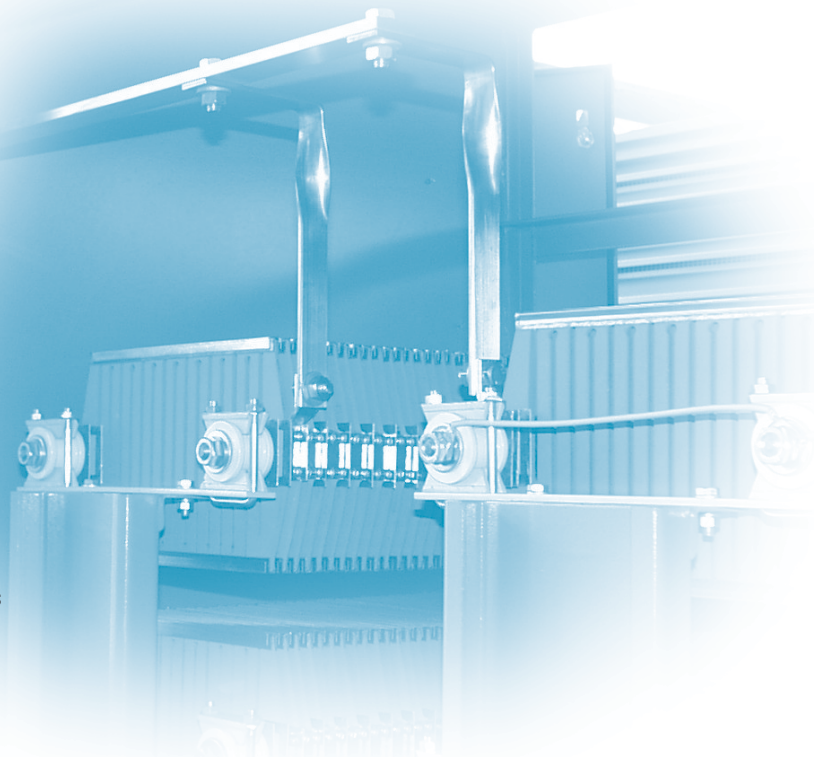

General

For systems with total current tripping, a relatively small maximum ground fault current may be selected, i.e. the ground resistor is sized such that the ground fault current is restricted to a value that is smaller than the nominal current. For systems with over-current tripping, the ground fault current must be larger than the nominal current so that it is safely recognized as an over-current. The value is normally specified as being 1.5 times to several times the nominal current. It should be selected such that on the one hand a ground fault at the peripherals of the network is still detected but that the ground fault current occurring in the immediate vicinity of the generator or transformer can still be managed without difficulties, on the other. This is influenced by the structure and protection of the individual system in question so that there are no general rules available. Where the system includes several generators or transformers, all grounding resistors should have the same value corresponding to the settings of the installed protection.

Although the protection facilities often react within seconds of a ground fault, a larger admissible ON time is selected for the resistor to enable for several connection attempts. Since the majority of ground faults result from flashovers on outdoor insulators whose arc is quenched by tripping, brief connection is required to reduce the operation downtime. A permanent ground fault will then result in a new load on the resistor.

The usual values for the admissible load period for a ground resistor are 5...10...15...20...30 seconds with 10 s being most frequently used. The demand for 30 s originates from the time when liquid resistors were used whose load period was defined by the amount of electrolytes, among others. For air-cooled metal resistors, 30 s load periods are economically not viable because, unlike the liquid resistors, they cool down relatively fast and the load period has a strong impact on the resistor price. Oil-cooled metal resistors are only suited where high protection and/or high load periods are required because the relatively low admissible oil temperature only enables for an incomplete utilization of the resistor material.

Resistors for indoor applications are manufactured in IP00 and IP20.

Resistor outdoor applications, at least IP23 is required.

Higher protection is problematic with a view to the restricted ventilation caused by the thermal load of the elements, insulators and housings.

Insulation is designed for the system voltages 12, 24, 36, 52 kV with larger clearance and/or creepage distances being required in some cases as a function of the place of installation, climatic conditions, soiling or the installation altitude.

Applicable codes and standards:

DIN 40050	Protections
DIN 57101/VDE 0101	Insulation coordination for utilities in three-phase circuits >1 kV
DIN 57111/VDE 0111	Installation of electrical power installations > 1 kV
DIN 57141/VDE 0141	Grounding in alternating current systems > 1 kV
IEC 273	Characteristics of indoor and outdoor post insulators
IEEEStd 32-1972	Requirements, Terminology and Test Procedures for Neutral Grounding Devices

GINO Grounding Resistors

GINO grounding resistors consist of the resistor packages with resistor elements made from siliconized cast iron with or without surface protection (e.g. zinc dust primer) or steel sheet grid elements made from various resistor materials. Several resistor packages can be combined to a withdrawable module, insulated from the housing and up to three modules can be arranged in one housing. One or several modules can also be combined for installation in existing switchgears on a base frame to form an IP00 resistor.

The housing design is influenced by the selected place of installation, among others. GINO/ESE grounding resistors type IP23 are only suited for installation in electrical operating areas. When installed outside of electrical operating areas, the enclosure must be such that a straight wire cannot touch any hazardous elements. If installation is planned in public locations, the wire may be of very small diameters. Protective measures in addition to those specified in DIN 40050 have to be taken.

Grounding resistor design

Indoor resistors are provided with a primer after sandblasting of the frame surface followed by a high-quality synthetic resin coat. Housings for outdoor applications are provided with a weather-proof two-component PUR paint coat comprising a 2-component primer and a 2-component top coat. The standard color is RAL 7032.

For installation, the customer shall provide a plane foundation with the requisite cable duct. The bottom of the housing is provided with wire mesh and removable bottom plates at suitable locations for cable connection.

As a rule, all terminals are provided with copper bars on the inside of the housing. The cables are inserted through the bottom of the housing or the side. Upon request and at extra cost, the resistors can also be provided with indoor or outdoor bushings or angle connectors for connection of the neutral conductor.

The insulation of the connection for operational earth depends on the conditions of the grounding system. Where a ground fault voltage U_E at the connecting point as per VDE00141 exceeds prerequisite 4 (V4) 3000 V, it has proven to be advantageous to also insulate the grounding connection for the system voltage or $1/\sqrt{3}$ times the system voltage. In all other cases it is possible to insulate for lower voltages and also to use LV transformers instead of the more expensive MV transformers, where applicable. Such preconditions are mostly found in applications where the admissible fault current is of only a few hundred amperes. A transformer to be installed in the ground resistor will take up the function of a (lower) resistor package and this has to be considered for the selection of the enclosure.

According to the VDE 0141 regulations, all conductive housing and frame parts that do not belong to the active circuit have to be conductively interconnected. Doors and removable cover sheets are provided with a separate ground connection.

For the connection of the protective ground the frames are provided with at least one grounding bolt M10 or with several M8 bolts.

Resistor modules, protection class IP00, installation

Size	No. of banks ¹⁾	Dimension H	Weight ca. kg
System voltage 12 kV, maximum 4 kV per bank			
1202	2	850	145
1203	3	1040	210
1204	4	1310	275
1205	5	1500	340
1206	6	1750	400
System voltage 24 kV, maximum 12 kV per module, maximum 4 kV per bank			
2402	2	940	150
2403	3	1130	215
2404	4	1400	280
2405	5	1590	345
2406	6	1840	405
System voltage 36 kV, maximum 12 kV per module, maximum 4 kV per bank			
3602	2	1050	155
3603	3	1240	220
3604	4	1510	285
3605	5	1700	350
3606	6	1950	410

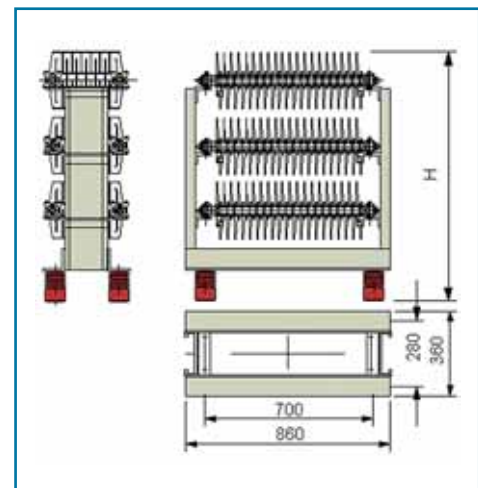

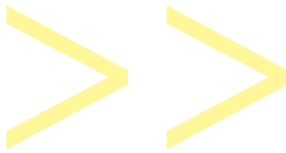

Housed resistors for outdoor installation, protection class IP23

Size	Modules	Max. no. of banks	Dimensions				Weight ca. kg
			W	D	H	H1	
System voltage 12 kV, maximum 4 kV per bank							
12102	1	2	800	1200	1500	1250	390
12103		3			1700	1450	470
12104		4			1950	1750	550
12105		5			2150	1900	630
12106		6			2400	2150	710
12208		2			8	1400	1200
12210	10		2150	1900	1150		
12212	12		2400	2150	1300		
12312	3	12	1800	1200	1950	1750	1350
12315		15			2150	1950	1570
12318		18			2400	2150	1780
System voltage 24 kV, maximum 12 kV per module, maximum 4 kV per bank							
24104	1	4	900	1400	2100	1825	710
24105		5			2300	2025	800
24106		6			2550	2275	890
24208	2	8	1500	1400	2100	1825	1090
24210		10			2300	2025	1250
24212		12			2550	2275	1400
24312	3	12	2000	1400	2100	1825	1450
24315		15			2300	2025	1680
24318		18			2500	2275	1900
System voltage 36 kV, maximum 12 kV per module, maximum 4 kV per bank							
36104	1	4	1200	1700	2300	1900	840
36105		5			2500	2100	930
36106		6			2750	2350	1020
36208	2	8	1800	1700	2300	1900	1230
36210		10			2500	2100	1400
36212		12			2750	2350	1550
36312	3	12	2300	1700	2300	1900	1610
36315		15			2500	2100	1830
36318		18			2750	2350	2060

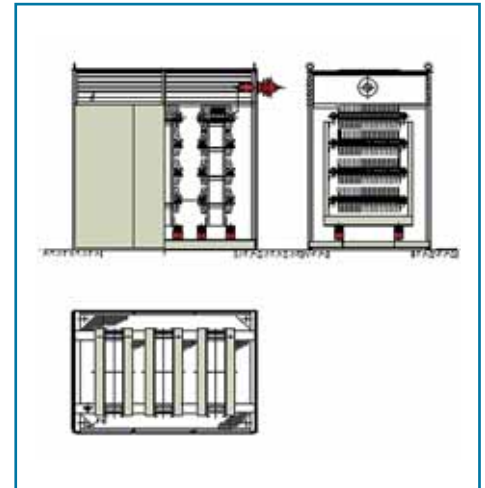

Notes

Information required:

- > System voltage
- > Ohm value R
- > Rated earth fault current $[I_g] = A$
- > Operating time s
- > Cont. Current, where applicable $[I_d] = A$
- > Protection class IPxx
- > Connection (cable, bushing)

Dimensioning:

- > Calculate current-time integral: $[I^2 t] = kA^2s$
- > Select element type GWE.. on page 1.19
- > Calculate the number of elements
 $n_{Elements} = R / R_{Elements}$
- > Calculate the number of banks
 $n_{Banks} = n_{Elements} / 48$ round up to full no. of banks,
 select even number of elements per bank, direct-axis
 voltage $I_f \cdot R_{Bank}$ per bank maximum 4 kV, increase
 number of banks, where required
- > Select module or housing size, observe criteria for
 system voltage $I_f \cdot R_{Module} \leq 4$ kV
- > Additional remarks in special brochure
 "Neutral point grounding resistors"

Special designs and accessories available

- > Galvanized housing, hot-dip galvanized frame, hot-dip galvanized sheet cladding, 2K PUR painting
- > Steel grid elements made from chromium nickel steel instead of cast iron
- > Higher protection class IP3x, IP4x, IP5x
- > Indoor / outdoor bushing HV side
- > Currency converter
- > Higher clearances and creepage distances with insulators
- > Disconnecting switch, 1-pole, different drives
- > Low voltage recess or terminal strip

Routine tests

- > Every resistor will be subjected to individual testing where in addition to the visual checking of the manufacture and verification of the part dimensions and paint coat thickness, the tests below will be conducted and recorded
- > Checking the resistor package as per IEEE Std 32-1972 by applying 2.25 times the longitudinal voltage + 2kV, 1 minute
- > Measuring of the d.c. resistance at ambient temperature
- > The dielectric strength is considered as evidenced given the use of tested insulators and observation of the minimum clearance distances as per VDE 0101 and VDE 0111

Special designs and additional equipment items

- > Galvanized housing, hot-dip galvanized frame, galvanized cladding, with 2-component PUR paint coat
- > Resistors with punched sheet elements made from corrosion and acid-proof chromium nickel steel 18 9, material number 1.4301/AISI304
- > Higher protection IP3x, IP4x, IP5x
- > Transformers, support-type current transformers or low voltage transformers on the ground connection side (see above remark)
- > Special design with higher clearance and creepage distances by using C- supports as per IEC 273
- > Disconnecter, single-pole, ring-type drive
- > Disconnecter, single-pole, track-control drive
- > Disconnecter, single-pole, with motor drive
- > Separate low-voltage compartment or terminal box

GINO GmbH
Elektrotechnische Fabrik
Friedrich-Wöhler-Str. 65
D-53117 Bonn

Phone: +49 228 98 98 6-0
Fax: +49 228 98 98 6-34

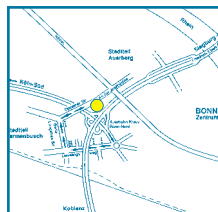

GINO GmbH
Elektrotechnische Fabrik
Heinrichstraße 47
D-99817 Eisenach

Phone: +49 36 91 77 7-0
Fax: +49 36 91 77 7-307

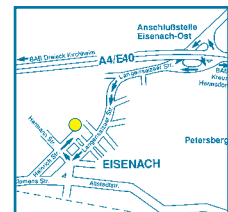

E-Mail: info@gino.de / Internet: www.gino.de